

Soluzioni primarie individuali 2024

		<p>1 4 2 < 3</p> <p style="text-align: center;">v</p> <p>3 2 4 1</p> <p>4 > 3 > 1 2</p> <p>2 > 1 3 < 4</p>																																																	
		<table border="1" style="width: 100%; border-collapse: collapse;"> <tbody> <tr><td>3</td><td>4</td><td>2</td><td>4</td><td>6</td><td>2</td><td>7</td></tr> <tr><td>7</td><td>2</td><td>7</td><td>7</td><td>3</td><td>4</td><td>5</td></tr> <tr><td>7</td><td>3</td><td>5</td><td>2</td><td>4</td><td>7</td><td>1</td></tr> <tr><td>2</td><td>1</td><td>1</td><td>6</td><td>2</td><td>7</td><td>1</td></tr> <tr><td>2</td><td>2</td><td>3</td><td>1</td><td>2</td><td>5</td><td>4</td></tr> <tr><td>5</td><td>6</td><td>1</td><td>1</td><td>7</td><td>3</td><td>6</td></tr> <tr><td>5</td><td>5</td><td>4</td><td>4</td><td>1</td><td>2</td><td>6</td></tr> </tbody> </table>	3	4	2	4	6	2	7	7	2	7	7	3	4	5	7	3	5	2	4	7	1	2	1	1	6	2	7	1	2	2	3	1	2	5	4	5	6	1	1	7	3	6	5	5	4	4	1	2	6
3	4	2	4	6	2	7																																													
7	2	7	7	3	4	5																																													
7	3	5	2	4	7	1																																													
2	1	1	6	2	7	1																																													
2	2	3	1	2	5	4																																													
5	6	1	1	7	3	6																																													
5	5	4	4	1	2	6																																													

Soluzioni medie individuali 2024

5	5	9	9	9	9
5	5	9	9	3	2
5	2	9	9	3	2
4	2	5	9	3	4
4	4	5	5	5	4
4	2	2	5	4	4

2 1

1 1 3 1 2

	A	C	A					
B				B	A	C	C	
C		C	A			B		
	A	B			C			
B	B		C	A			A	
B			B	C			A	
	C	A				B		
						B	C	B

M	I	A	I	A	O
O	M	O	M	O	M
M	A	I	A	I	I
A	I	A	M	O	A
O	M	I	O	M	I
I	A	O	M	A	O

	1		2		
2			2		
	1	2	2		
	1				0
0		2	2		

4 1 2 2 0 1 4

2							
1							
2							
2							
2							
1							
4							

	1				2			
3		4			5	3		
							3	
		4					3	
		1			2			
	0		2					
							3	
							0	

		+	-		+
 					
					+
				-	
	+		 		-
 			-		+

6 2 2 3 2 3 4

1					
4					
5					
3					
3					
4					
2					

		1	2	3
3	2			1
	1		3	2
1	3	2		
2		3	1	

2			4		1	
	4				5	
		3	5	2		
		1			3	
	4		1			
5		2		3	1	4
	3		5		2	

Soluzioni triennio individuali 2024

	<table border="1" style="width: 100%; border-collapse: collapse;"> <tr><td>4</td><td>1</td><td>2</td><td>3</td><td>2</td></tr> <tr><td>3</td><td>2</td><td>3</td><td>1</td><td>4</td></tr> <tr><td>4</td><td>1</td><td>4</td><td>2</td><td>3</td></tr> <tr><td>1</td><td>4</td><td>2</td><td>3</td><td>1</td></tr> <tr><td>3</td><td>2</td><td>3</td><td>2</td><td>3</td></tr> <tr><td>4</td><td>1</td><td>4</td><td>1</td><td>4</td></tr> </table>	4	1	2	3	2	3	2	3	1	4	4	1	4	2	3	1	4	2	3	1	3	2	3	2	3	4	1	4	1	4	<table border="1" style="width: 100%; border-collapse: collapse;"> <tr><td></td><td></td><td>2</td><td>1</td><td></td></tr> <tr><td></td><td></td><td>2</td><td>3</td><td>1</td></tr> <tr><td>1</td><td>2</td><td>3</td><td>4</td><td>2</td><td>3</td></tr> <tr><td></td><td></td><td>2</td><td></td><td>1</td><td></td></tr> <tr><td>1</td><td>3</td><td>2</td><td>4</td><td>2</td><td></td></tr> <tr><td></td><td>1</td><td></td><td>2</td><td>3</td><td>1</td></tr> </table>			2	1				2	3	1	1	2	3	4	2	3			2		1		1	3	2	4	2			1		2	3	1																																																																																																					
4	1	2	3	2																																																																																																																																																																			
3	2	3	1	4																																																																																																																																																																			
4	1	4	2	3																																																																																																																																																																			
1	4	2	3	1																																																																																																																																																																			
3	2	3	2	3																																																																																																																																																																			
4	1	4	1	4																																																																																																																																																																			
		2	1																																																																																																																																																																				
		2	3	1																																																																																																																																																																			
1	2	3	4	2	3																																																																																																																																																																		
		2		1																																																																																																																																																																			
1	3	2	4	2																																																																																																																																																																			
	1		2	3	1																																																																																																																																																																		
		<table border="1" style="width: 100%; border-collapse: collapse;"> <tr><td>→</td><td>↓</td><td>↘</td><td>⇒</td><td>↙</td><td>↗</td></tr> <tr><td>↘</td><td>↙</td><td>↓</td><td>↗</td><td>↘</td><td>↙</td></tr> <tr><td>↗</td><td>↘</td><td>↑</td><td>↓</td><td>⇒</td><td>↙</td></tr> <tr><td>↘</td><td>↙</td><td>↑</td><td>↑</td><td>↗</td><td>↘</td></tr> <tr><td>⇒</td><td>↑</td><td>↘</td><td>↑</td><td>↙</td><td>⇐</td></tr> <tr><td>↑</td><td>⇒</td><td>⇒</td><td>↗</td><td>⇐</td><td>⇐</td></tr> </table>	→	↓	↘	⇒	↙	↗	↘	↙	↓	↗	↘	↙	↗	↘	↑	↓	⇒	↙	↘	↙	↑	↑	↗	↘	⇒	↑	↘	↑	↙	⇐	↑	⇒	⇒	↗	⇐	⇐																																																																																																																																	
→	↓	↘	⇒	↙	↗																																																																																																																																																																		
↘	↙	↓	↗	↘	↙																																																																																																																																																																		
↗	↘	↑	↓	⇒	↙																																																																																																																																																																		
↘	↙	↑	↑	↗	↘																																																																																																																																																																		
⇒	↑	↘	↑	↙	⇐																																																																																																																																																																		
↑	⇒	⇒	↗	⇐	⇐																																																																																																																																																																		
<table border="1" style="width: 100%; border-collapse: collapse;"> <tr><td>○</td><td>○</td><td>○</td><td>○</td><td>○</td><td>○</td></tr> <tr><td>○</td><td>●</td><td>●</td><td>○</td><td>●</td><td>○</td></tr> <tr><td>○</td><td>○</td><td>●</td><td>○</td><td>●</td><td>○</td></tr> <tr><td>○</td><td>●</td><td>●</td><td>●</td><td>●</td><td>●</td></tr> <tr><td>○</td><td>●</td><td>○</td><td>●</td><td>○</td><td>●</td></tr> <tr><td>○</td><td>○</td><td>○</td><td>○</td><td>○</td><td>○</td></tr> </table>	○	○	○	○	○	○	○	●	●	○	●	○	○	○	●	○	●	○	○	●	●	●	●	●	○	●	○	●	○	●	○	○	○	○	○	○	<table border="1" style="width: 100%; border-collapse: collapse;"> <tr><td></td><td>1</td><td></td><td>28</td><td>29</td><td>30</td><td>1</td></tr> <tr><td>4</td><td>3</td><td>2</td><td>26</td><td>27</td><td>31</td><td>2</td></tr> <tr><td>5</td><td></td><td></td><td>25</td><td></td><td></td><td>0</td></tr> <tr><td>6</td><td></td><td></td><td>24</td><td>23</td><td>22</td><td>3</td></tr> <tr><td>7</td><td></td><td></td><td></td><td></td><td>20</td><td>0</td></tr> <tr><td>8</td><td></td><td></td><td></td><td></td><td>19</td><td>0</td></tr> <tr><td>9</td><td>10</td><td>11</td><td>12</td><td>16</td><td>17</td><td>18</td><td>3</td></tr> <tr><td></td><td></td><td>13</td><td>14</td><td>15</td><td></td><td></td><td>1</td></tr> <tr><td>2</td><td>1</td><td>0</td><td>1</td><td>1</td><td>2</td><td>0</td><td>3</td></tr> </table>		1		28	29	30	1	4	3	2	26	27	31	2	5			25			0	6			24	23	22	3	7					20	0	8					19	0	9	10	11	12	16	17	18	3			13	14	15			1	2	1	0	1	1	2	0	3	<table border="1" style="width: 100%; border-collapse: collapse;"> <tr><td>i</td><td></td><td></td><td></td><td>i</td><td></td><td></td></tr> <tr><td></td><td>i</td><td></td><td>i</td><td></td><td></td><td></td></tr> <tr><td></td><td></td><td></td><td></td><td>i</td><td></td><td>i</td></tr> <tr><td></td><td>i</td><td></td><td>i</td><td></td><td></td><td></td></tr> <tr><td></td><td></td><td></td><td></td><td>i</td><td></td><td>i</td></tr> <tr><td></td><td>i</td><td></td><td>i</td><td></td><td></td><td></td></tr> <tr><td></td><td></td><td></td><td></td><td>i</td><td></td><td>i</td></tr> <tr><td>i</td><td>i</td><td></td><td></td><td></td><td></td><td></td></tr> <tr><td></td><td></td><td></td><td></td><td>i</td><td></td><td>i</td></tr> </table>	i				i				i		i								i		i		i		i								i		i		i		i								i		i	i	i										i		i
○	○	○	○	○	○																																																																																																																																																																		
○	●	●	○	●	○																																																																																																																																																																		
○	○	●	○	●	○																																																																																																																																																																		
○	●	●	●	●	●																																																																																																																																																																		
○	●	○	●	○	●																																																																																																																																																																		
○	○	○	○	○	○																																																																																																																																																																		
	1		28	29	30	1																																																																																																																																																																	
4	3	2	26	27	31	2																																																																																																																																																																	
5			25			0																																																																																																																																																																	
6			24	23	22	3																																																																																																																																																																	
7					20	0																																																																																																																																																																	
8					19	0																																																																																																																																																																	
9	10	11	12	16	17	18	3																																																																																																																																																																
		13	14	15			1																																																																																																																																																																
2	1	0	1	1	2	0	3																																																																																																																																																																
i				i																																																																																																																																																																			
	i		i																																																																																																																																																																				
				i		i																																																																																																																																																																	
	i		i																																																																																																																																																																				
				i		i																																																																																																																																																																	
	i		i																																																																																																																																																																				
				i		i																																																																																																																																																																	
i	i																																																																																																																																																																						
				i		i																																																																																																																																																																	
<table border="1" style="width: 100%; border-collapse: collapse;"> <tr><td></td><td>●</td><td>8</td><td></td><td></td><td></td></tr> <tr><td>●</td><td>9</td><td></td><td>●</td><td></td><td>●</td></tr> <tr><td></td><td></td><td></td><td>5</td><td></td><td></td></tr> <tr><td>5</td><td>5</td><td>●</td><td>5</td><td></td><td>3</td></tr> <tr><td></td><td></td><td>2</td><td>●</td><td></td><td>4</td></tr> <tr><td></td><td>2</td><td></td><td></td><td></td><td></td></tr> <tr><td>●</td><td></td><td></td><td></td><td></td><td></td></tr> <tr><td></td><td>1</td><td>3</td><td>●</td><td></td><td>●</td></tr> </table>		●	8				●	9		●		●				5			5	5	●	5		3			2	●		4		2					●							1	3	●		●	<table border="1" style="width: 100%; border-collapse: collapse;"> <tr><td></td><td>2</td><td></td><td>3</td><td></td><td>1</td></tr> <tr><td></td><td></td><td>1</td><td>0</td><td></td><td></td></tr> <tr><td></td><td></td><td>1</td><td></td><td>2</td><td></td></tr> <tr><td></td><td></td><td></td><td>4</td><td></td><td></td></tr> <tr><td></td><td></td><td></td><td></td><td></td><td>4</td></tr> <tr><td></td><td></td><td>5</td><td></td><td></td><td></td></tr> <tr><td></td><td>2</td><td></td><td>0</td><td></td><td>6</td></tr> <tr><td>5</td><td></td><td></td><td>1</td><td></td><td></td></tr> </table>		2		3		1			1	0					1		2					4								4			5					2		0		6	5			1			<table border="1" style="width: 100%; border-collapse: collapse;"> <tr><td></td><td></td><td>C₂</td><td>D₁</td><td>A₄</td><td>D₄</td><td>A₃</td><td></td></tr> <tr><td>A₂</td><td>D</td><td>A</td><td></td><td>C</td><td></td><td>B</td><td>C₂</td></tr> <tr><td></td><td>B</td><td>C</td><td>D</td><td></td><td>A</td><td></td><td>A₁</td></tr> <tr><td>D₂</td><td>A</td><td>D</td><td></td><td>B</td><td>C</td><td></td><td>B₂</td></tr> <tr><td>C₁</td><td>C</td><td>B</td><td>A</td><td></td><td></td><td>D</td><td>B₃</td></tr> <tr><td>D₂</td><td></td><td></td><td>C</td><td>D</td><td>B</td><td>A</td><td></td></tr> <tr><td></td><td></td><td></td><td>B</td><td>A</td><td>D</td><td>C</td><td></td></tr> <tr><td>A₂</td><td></td><td>C₂</td><td>B₃</td><td></td><td>D₃</td><td></td><td></td></tr> </table>			C ₂	D ₁	A ₄	D ₄	A ₃		A ₂	D	A		C		B	C ₂		B	C	D		A		A ₁	D ₂	A	D		B	C		B ₂	C ₁	C	B	A			D	B ₃	D ₂			C	D	B	A					B	A	D	C		A ₂		C ₂	B ₃		D ₃							
	●	8																																																																																																																																																																					
●	9		●		●																																																																																																																																																																		
			5																																																																																																																																																																				
5	5	●	5		3																																																																																																																																																																		
		2	●		4																																																																																																																																																																		
	2																																																																																																																																																																						
●																																																																																																																																																																							
	1	3	●		●																																																																																																																																																																		
	2		3		1																																																																																																																																																																		
		1	0																																																																																																																																																																				
		1		2																																																																																																																																																																			
			4																																																																																																																																																																				
					4																																																																																																																																																																		
		5																																																																																																																																																																					
	2		0		6																																																																																																																																																																		
5			1																																																																																																																																																																				
		C ₂	D ₁	A ₄	D ₄	A ₃																																																																																																																																																																	
A ₂	D	A		C		B	C ₂																																																																																																																																																																
	B	C	D		A		A ₁																																																																																																																																																																
D ₂	A	D		B	C		B ₂																																																																																																																																																																
C ₁	C	B	A			D	B ₃																																																																																																																																																																
D ₂			C	D	B	A																																																																																																																																																																	
			B	A	D	C																																																																																																																																																																	
A ₂		C ₂	B ₃		D ₃																																																																																																																																																																		

Soluzioni stanza 1 2024

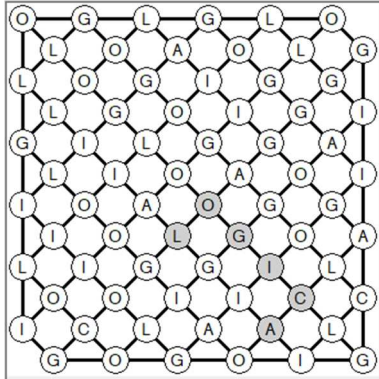

$p=2$

2	4	4	5	5	5	5	3
2	9	4	2	2	5	3	3
9	9	4	3	3	4	2	2
9	9	9	9	3	4	4	3
9	3	9	5	5	2	4	3
2	3	5	5	5	2	5	3
2	3	4	3	3	5	5	5
4	4	4	1	3	5	2	2

$a=2$ $b=3$

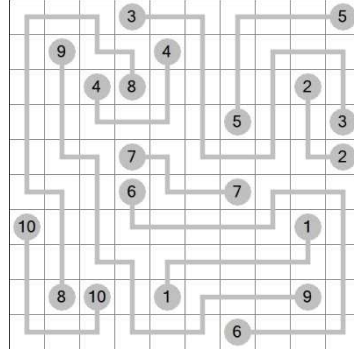

$c=5$ $d=5$ $e=6$

		B	B		
A	A	B		C	
	C	A	B		B
	B			A	C
C			C	B	A
		C	A		B

$x=1$ $y=2$

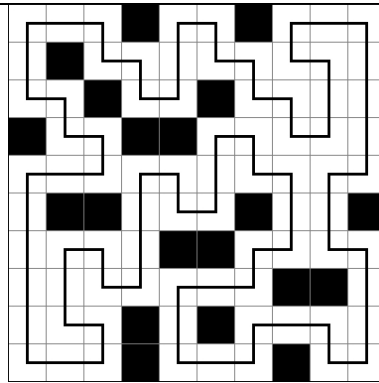

$w=2$ $r=4$

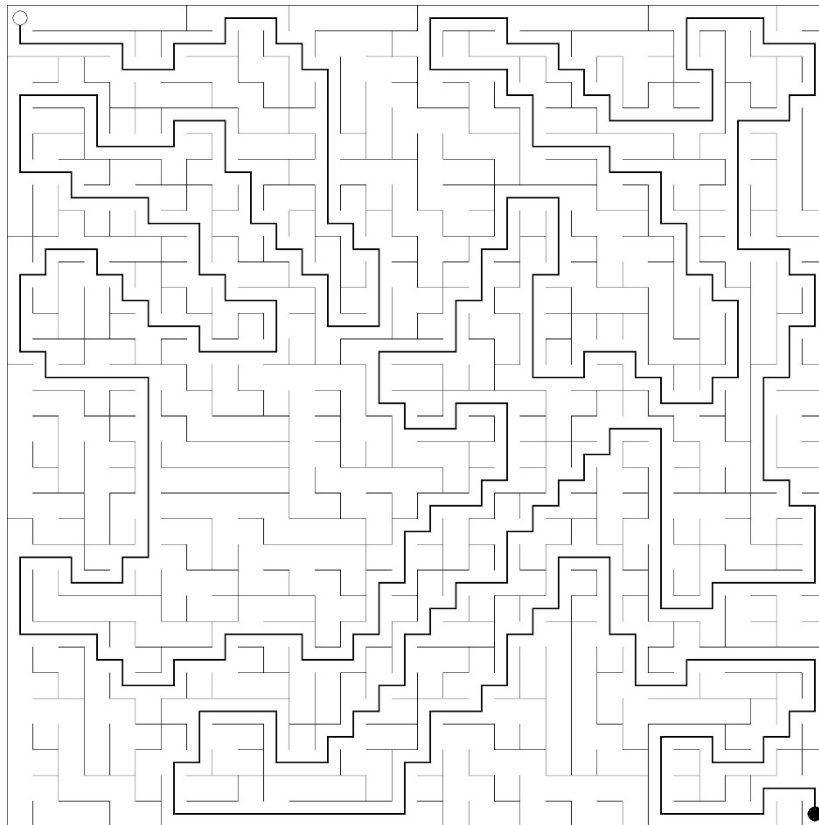

CODICE DI USCITA: 4732022225

Soluzioni stanza 2 2024

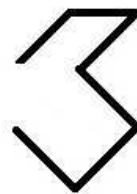
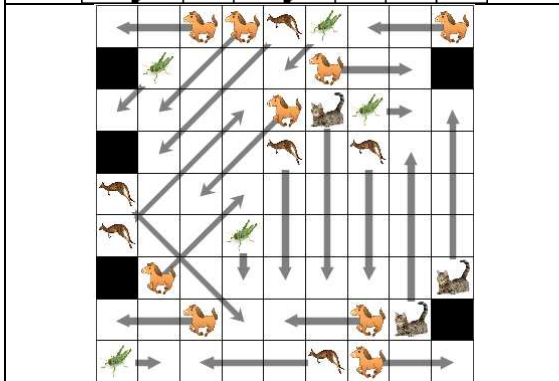
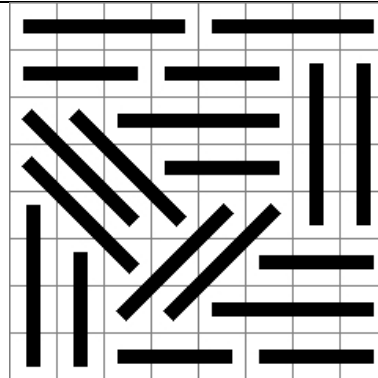
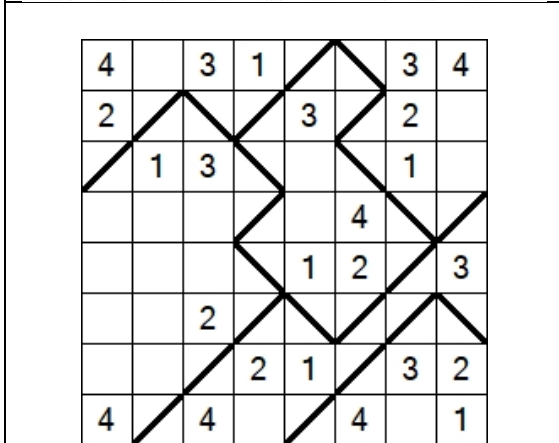
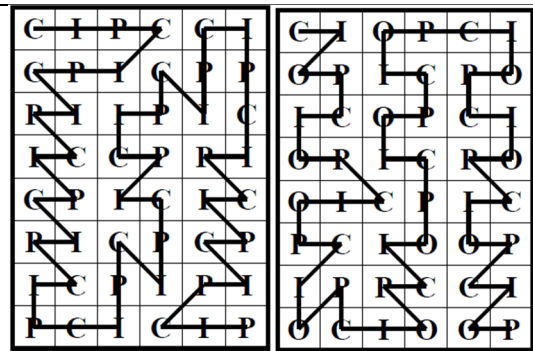
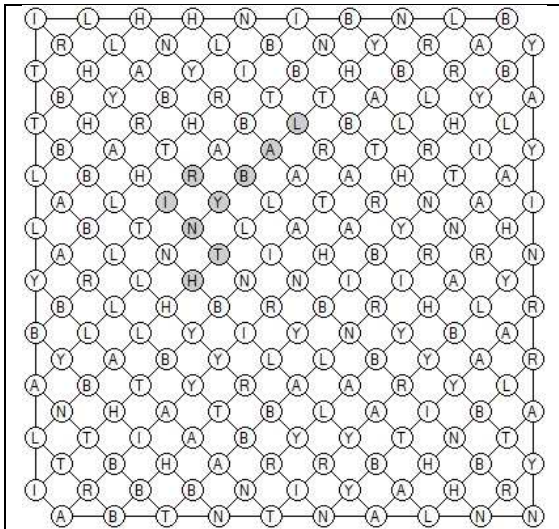

7095324

Soluzioni stanza 3 2024

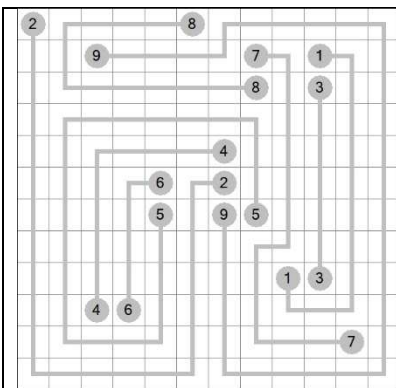

R=9 P=5 L=2

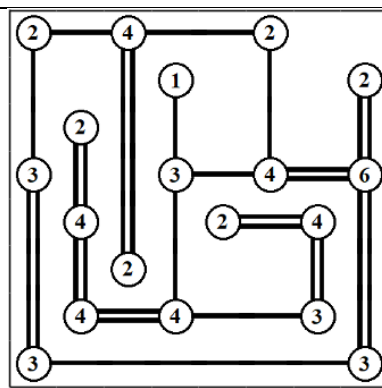

R=1 P=4 L=3

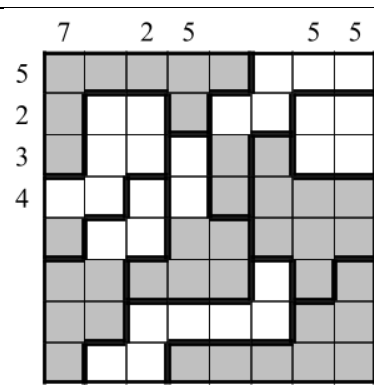

R= P=4 L=6

6	6	2	2	3	3	3
6	6	6	6	9	9	2
2	4	9	9	9	9	2
2	4	9	9	9	2	4
5	4	3	3	5	2	4
5	4	3	5	5	1	4
5	5	5	1	5	5	4

R=1 P=3 L=2

1	6	5	2	1	6
3	5	1	6	1	2
3	2	1	3	1	5
4	3	3	1	2	1
6	2	3	4	2	1
2	6	3	5	3	4

R=2 P=5 L=6

1	💣	💣	💣	💣	3	2	
		4	3		3	💣	💣
0		💣		0		💣	3
0			3				
		💣	5	💣		💣	
	4	💣	💣	💣	4	1	1
💣	4	💣	6	💣			0
💣	3	2	💣		💣		

R=3 P=1 L=3

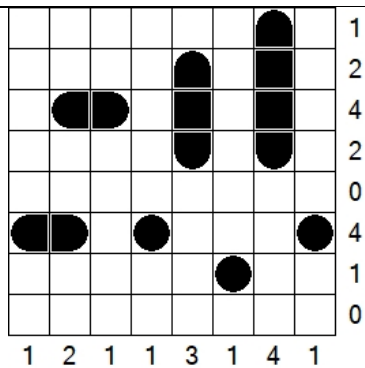

R=2 P=1 L=4

FRAGOLA

VOGLIO PROPRIO **S**FIDARVI: **T**RA QUESTE INNOCENTI RIGHE SI NASCONDE QUELLA **P**AROLA CHIAVE CHE VI PERMETTE DI USCIRE DA QUESTA STANZA. MA PRIMA DOVETE RISOLVERE I SETTE GIOCHI, ALTRIMENTI NON LA TROVERETE MAI. ANALOGAMENTE A QUANTO FATTO ALTRE VOLTE, SI TRATTA DI UNA PAROLA MOLTO COMUNE, CONOSCIUTA DA CHIUNQUE; SONO SICURO CHE **A**LLA FINE, UNA VOLTA SCOPERTO IL TRUCCO, NON AVRETE PROBLEMI A INDOVINARLA. BUONA CACCIA!

Soluzioni stanza 4 2024

			F			
			D	I		
	E				D	E
						B
		S	F		I	
			G			
			B			
		S				G

EFFE SEI

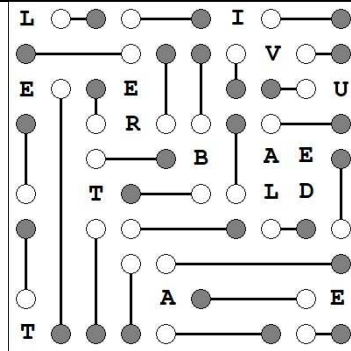

Leggendo in verticale le lettere rimaste scoperte:
LETTERA BI VALE DUE
 (Nota: leggendo in orizzontale le lettere cancellate si ottiene **QUESTE LETTERE SONO DEL TUTTO INUTILI**)

→	R	L	A	A	T	I
→	V	A	L	V	E	A
	A	R	E	T	L	R
→	L	T	E	R	T	E
	L	V	R	E	A	I
	R	T	T	A	I	V

LA TI VALE TRE

K	A	K	U	R	O	E	B	L	A	G	N	O	L	I	T	V	A	R	G	
C	A	M	P	I	N	O	G	O	I	G	L	B	L	O	O	M	A	I		
L	C	A	E	M	I	S	I	E	L	S	E	S	A	R	U	M	K	E		
O	E	R	O	S	T	R	O	N	T	A	T	L	L	E	S	A	C			
L	G	N	R	E	I	O	E	O	O	O	O	I	A	T	E	I	R	A		
A	O	A	E	C	R	M	M	I	K	A	L	I	M	O	E	T	N	S	N	
L	L	O	N	E	H	N	U	L	G	U	L	L	E	M	E	G	R	L	I	
S	M	O	D	E	A	O	N	E	T	A	P	R	E	T	I	Z	N	E	A	F

N=7

						1
						1 0
						2 1
						2 1
	2			1	2	
		5		3	5	
2		3	3	4		3

4

		i		i		
	i					i
			i		i	
i		i				
				i		i
		i				
i						
			i			
	i					i

C3

	B	B				A
	B				C	A
	A				B	C
C	C		A			B
B		B		C	A	
		C	B	A		
A		A	C	B		
	C		C	B	A	

ACCA

E	X	T	R	A	P	O	L	O
S		R		G				B
S		E		R		H	U	B
E		N		A				L
N		O		R	E	S		I
Z				I				G
E	D	U	C	A	T	I	V	O

U5

	2	4	4		2
3					
5					

E1

SOLITARIO=5+4+2+2+3+4+5+2+4=31

Soluzioni stanza 5 2024

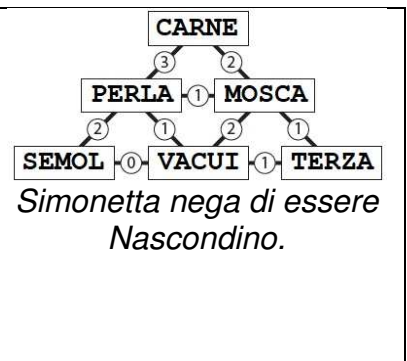
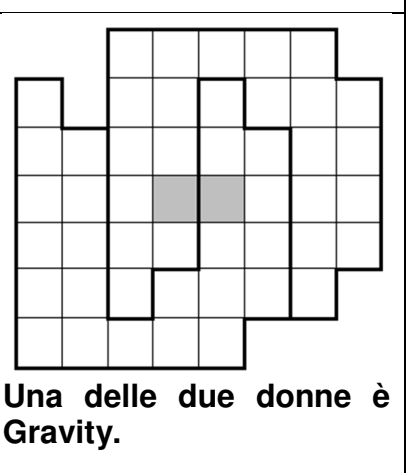
<p>$1+6+10=17$ Abita a Trento il personaggio con i capelli viola.</p>	<table border="1" style="border-collapse: collapse; margin: auto;"> <tr><td>1</td><td>3</td><td>2</td><td>3</td><td>2</td><td>1</td><td></td><td></td><td>1</td><td></td></tr> <tr><td></td><td>2</td><td></td><td>1</td><td></td><td></td><td></td><td></td><td>2</td><td>4</td><td>1</td></tr> <tr><td>1</td><td>4</td><td>2</td><td></td><td>1</td><td></td><td>1</td><td>4</td><td>2</td><td></td></tr> <tr><td></td><td>3</td><td>4</td><td>2</td><td>4</td><td>2</td><td></td><td>2</td><td></td><td>1</td></tr> <tr><td>2</td><td>4</td><td>2</td><td></td><td>2</td><td>4</td><td>2</td><td>4</td><td>3</td><td>2</td></tr> <tr><td>3</td><td>2</td><td></td><td>1</td><td></td><td>2</td><td></td><td>3</td><td>2</td><td></td></tr> <tr><td>2</td><td></td><td>1</td><td>4</td><td>2</td><td>3</td><td></td><td>2</td><td></td><td></td></tr> <tr><td>3</td><td>1</td><td></td><td>1</td><td></td><td>1</td><td></td><td>3</td><td>2</td><td></td></tr> <tr><td>1</td><td></td><td>1</td><td></td><td>1</td><td></td><td>2</td><td>4</td><td>3</td><td>2</td></tr> <tr><td></td><td>1</td><td>3</td><td>2</td><td>3</td><td>2</td><td>3</td><td>2</td><td></td><td>1</td></tr> </table> <p>Arnaldo ha i capelli biondi.</p>	1	3	2	3	2	1			1			2		1					2	4	1	1	4	2		1		1	4	2			3	4	2	4	2		2		1	2	4	2		2	4	2	4	3	2	3	2		1		2		3	2		2		1	4	2	3		2			3	1		1		1		3	2		1		1		1		2	4	3	2		1	3	2	3	2	3	2		1	 <p><i>Simonetta nega di essere Nascondino.</i></p>								
1	3	2	3	2	1			1																																																																																																							
	2		1					2	4	1																																																																																																					
1	4	2		1		1	4	2																																																																																																							
	3	4	2	4	2		2		1																																																																																																						
2	4	2		2	4	2	4	3	2																																																																																																						
3	2		1		2		3	2																																																																																																							
2		1	4	2	3		2																																																																																																								
3	1		1		1		3	2																																																																																																							
1		1		1		2	4	3	2																																																																																																						
	1	3	2	3	2	3	2		1																																																																																																						
<table border="1" style="border-collapse: collapse; margin: auto;"> <tr><td></td><td></td><td>x</td><td>x</td><td>x</td></tr> <tr><td></td><td></td><td>3</td><td>4</td><td>5</td></tr> <tr><td></td><td></td><td></td><td></td><td></td></tr> <tr><td></td><td></td><td></td><td>x</td><td></td></tr> <tr><td></td><td></td><td></td><td>14</td><td></td></tr> <tr><td>x</td><td></td><td></td><td></td><td></td></tr> <tr><td>16</td><td></td><td></td><td></td><td></td></tr> <tr><td></td><td>x</td><td></td><td></td><td></td></tr> <tr><td></td><td>22</td><td></td><td></td><td></td></tr> </table> <p>Il personaggio con i capelli rossi non ha gli occhi verdi.</p>			x	x	x			3	4	5									x					14		x					16						x					22				<table border="1" style="border-collapse: collapse; margin: auto;"> <tr><td></td><td>2</td><td>1</td><td>A</td><td>A</td><td>3</td><td>1</td><td></td></tr> <tr><td></td><td>B</td><td>C</td><td>3</td><td>2</td><td>1</td><td>A</td><td>3</td></tr> <tr><td>A</td><td>2</td><td>3</td><td>1</td><td>A</td><td>B</td><td>C</td><td>2</td></tr> <tr><td></td><td>1</td><td>2</td><td>A</td><td>B</td><td>C</td><td>3</td><td></td></tr> <tr><td></td><td>C</td><td>1</td><td>2</td><td>3</td><td>A</td><td>B</td><td>B</td></tr> <tr><td>A</td><td>3</td><td>A</td><td>B</td><td>C</td><td>2</td><td>1</td><td>3</td></tr> <tr><td>A</td><td>A</td><td>B</td><td>C</td><td>1</td><td>3</td><td>2</td><td></td></tr> <tr><td></td><td>B</td><td></td><td>2</td><td>A</td><td>B</td><td></td><td></td></tr> </table> <p>A Rovigo vive il personaggio con gli occhi neri.</p>		2	1	A	A	3	1			B	C	3	2	1	A	3	A	2	3	1	A	B	C	2		1	2	A	B	C	3			C	1	2	3	A	B	B	A	3	A	B	C	2	1	3	A	A	B	C	1	3	2			B		2	A	B			 <p>Una delle due donne è Gravity.</p>
		x	x	x																																																																																																											
		3	4	5																																																																																																											
			x																																																																																																												
			14																																																																																																												
x																																																																																																															
16																																																																																																															
	x																																																																																																														
	22																																																																																																														
	2	1	A	A	3	1																																																																																																									
	B	C	3	2	1	A	3																																																																																																								
A	2	3	1	A	B	C	2																																																																																																								
	1	2	A	B	C	3																																																																																																									
	C	1	2	3	A	B	B																																																																																																								
A	3	A	B	C	2	1	3																																																																																																								
A	A	B	C	1	3	2																																																																																																									
	B		2	A	B																																																																																																										
<table border="1" style="border-collapse: collapse; margin: auto;"> <tr><td></td><td>3</td><td>3</td><td>2</td><td>2</td><td>1</td><td></td></tr> <tr><td>1</td><td>3</td><td></td><td>1</td><td></td><td>2</td><td></td><td>2</td></tr> <tr><td></td><td></td><td></td><td>1</td><td>3</td><td>2</td><td></td><td>2</td></tr> <tr><td>3</td><td></td><td>1</td><td>2</td><td></td><td></td><td></td><td>3</td></tr> <tr><td></td><td>2</td><td>3</td><td></td><td></td><td></td><td></td><td>1</td></tr> <tr><td>1</td><td></td><td>3</td><td></td><td></td><td>1</td><td></td><td>2</td></tr> <tr><td></td><td>2</td><td></td><td></td><td>3</td><td></td><td>1</td><td></td><td>2</td></tr> <tr><td>⇒</td><td>1</td><td></td><td></td><td>2</td><td></td><td>3</td><td></td><td></td></tr> <tr><td></td><td>3</td><td></td><td>2</td><td></td><td>1</td><td></td><td></td><td></td></tr> </table> <p><i>Matteo insiste nell'affermare che una delle spie ha i capelli castani.</i></p>		3	3	2	2	1		1	3		1		2		2				1	3	2		2	3		1	2				3		2	3					1	1		3			1		2		2			3		1		2	⇒	1			2		3				3		2		1																																								
	3	3	2	2	1																																																																																																										
1	3		1		2		2																																																																																																								
			1	3	2		2																																																																																																								
3		1	2				3																																																																																																								
	2	3					1																																																																																																								
1		3			1		2																																																																																																								
	2			3		1		2																																																																																																							
⇒	1			2		3																																																																																																									
	3		2		1																																																																																																										
<table border="1" style="width: 100%; border-collapse: collapse;"> <thead> <tr> <th>Personaggio</th> <th>Nome</th> <th>Occhi</th> <th>Capelli</th> <th>Città</th> <th>Spia (sì/no)</th> </tr> </thead> <tbody> <tr> <td>Akari</td> <td>Arnaldo</td> <td>Verdi</td> <td>Biondi</td> <td>Ferrara</td> <td>Sì</td> </tr> <tr> <td>Battaglia navale</td> <td>Matteo</td> <td>Acquamarina</td> <td>Rossi</td> <td>Modena</td> <td>Sì</td> </tr> <tr> <td>Gravity</td> <td>Federica</td> <td>Azzurri</td> <td>Viola</td> <td>Trento</td> <td>Sì</td> </tr> <tr> <td>Nascondino</td> <td>Simonetta</td> <td>Neri</td> <td>Bianchi</td> <td>Rovigo</td> <td>Sì</td> </tr> <tr> <td>Ponti</td> <td>Giuseppe</td> <td>Nocciola</td> <td>Castani</td> <td>Lucca</td> <td>No</td> </tr> </tbody> </table>						Personaggio	Nome	Occhi	Capelli	Città	Spia (sì/no)	Akari	Arnaldo	Verdi	Biondi	Ferrara	Sì	Battaglia navale	Matteo	Acquamarina	Rossi	Modena	Sì	Gravity	Federica	Azzurri	Viola	Trento	Sì	Nascondino	Simonetta	Neri	Bianchi	Rovigo	Sì	Ponti	Giuseppe	Nocciola	Castani	Lucca	No																																																																						
Personaggio	Nome	Occhi	Capelli	Città	Spia (sì/no)																																																																																																										
Akari	Arnaldo	Verdi	Biondi	Ferrara	Sì																																																																																																										
Battaglia navale	Matteo	Acquamarina	Rossi	Modena	Sì																																																																																																										
Gravity	Federica	Azzurri	Viola	Trento	Sì																																																																																																										
Nascondino	Simonetta	Neri	Bianchi	Rovigo	Sì																																																																																																										
Ponti	Giuseppe	Nocciola	Castani	Lucca	No																																																																																																										